

# AFTERMARKET

# PRODUCT CATALOG



Above. Beyond. Always.





The StepAbove® family of products offers a simple, secure and safe way to enter and exit your trailer. A growing line of steps have been designed to fit the requirements of your RV.

# WHICH STEP IS RIGHT FOR YOUR RV?



p3

## STEPABOVE®

The StepAbove RV entry step system gives you more stability, security and safety as you enter and exit your RV. Ideal for most travel trailers and 5th wheels.



p5

## FLIP TREAD

These steps are ideal for normal entry doors as well as floor plans with interior steps that protrude into the doorway.

Have a Toyhauler? This step gives you maximum storage space so you have plenty of room for all of your toys!



p4

## STRUT ASSIST

Easily operate your StepAbove step system for your trailer or 5th wheel with our innovative strut assist. The zero gravity step you can lift with a finger.



p6

## PATIO

The ground stable patio steps offer added stability and safety as you enter and exit your rear or side patio.



p5

## QUICK CONNECT

The clip-on step that attaches to the outside of your unit. The choice when a StepAbove doesn't work with your unit.



p6

## AIRSTREAM®

Give yourself sure footing into and out of your Airstream® with a StepAbove RV step system.

**STILL UNSURE ABOUT WHICH STEP IS RIGHT FOR YOU?**

Give us a call at 574.293.1581 or email [parts@morryde.com](mailto:parts@morryde.com) for more information.



# STEPABOVE®

Upgrade your trailer or 5th wheel with our innovative StepAbove step system to give you bounce-free, wobble-free stability. With adjustable feet (no dealing with annoying pins) you get a level step every time – even rough terrain is no problem for your StepAbove. Easily store and lock your StepAbove into your door entrance.

## FEATURES

- Lightweight
- Stable entry when entering and exiting your RV
- Deep top step for better footing
- Quick-release leg adjustment
- Gradual step slope for easier usage
- Easy removal in tight spaces



**INDUSTRY-LEADING 500lb  
WEIGHT CAPACITY**



**LEARN MORE** about the **STEPABOVE**



**BEFORE YOU ORDER —**  
Review the **Qualification Guide** to determine the correct StepAbove for your unit.



## STEPABOVE FIT CHART

	PART NUMBER	STEP HEIGHT	STEP RISE	DOOR WIDTH Size from Factory Label	—OR—	DOOR WIDTH Size from Flange to Flange
<b>2 STEP</b>	STP-201	25" – 29.5"	9"	24"		21.75" – 22.25"
	STP-202	25" – 29.5"	9"	26" – 28"		23.75" – 26.25"
<b>3 STEP</b>	STP-203	34" – 37"	9"	24"		21.75" – 22.25"
	STP-204	30" – 33.5"	8"	24"		21.75" – 22.25"
	STP-206	30" – 33.5"	8"	26" – 28"		23.75" – 26.25"
	STP-207	34" – 37"	9"	26" – 28"		23.75" – 26.25"
	STP-208	30" – 33.5"	8"	30" – 32"		27.75" – 30.25"
	STP-209	34" – 37"	9"	30" – 32"		27.75" – 30.25"
<b>4 STEP</b>	STP-212	37.5" – 42"	8"	26" – 28"		23.75" – 26.25"
	STP-213	37.5" – 42"	8"	30" – 32"		27.75" – 30.25"

# STRUT ASSIST STEP

Easily operate your StepAbove step system for your travel trailer or 5th wheel with our innovative strut assist. The Strut Step offers a self-contained, ground stable entry system to more effortlessly operate your StepAbove while still providing sure footing when entering and exiting your RV.

FEATURES

- Gas struts create lightweight operation
- Easily lift and lower design
- Convenient storage
- Industry-leading 500 lb weight capacity



EASILY LIFT WITH ONE FINGER

## STRUT ASSIST FIT CHART

	PART NUMBER	STEP HEIGHT	STEP RISE	DOOR WIDTH Size from Factory Label	—OR—	DOOR WIDTH Size from Flange to Flange
3 STEP	STP-205	31.5" – 37"	9"	26"		23.75" – 24.25"
	STP-210	31.5" – 37"	9"	30"		27.75" – 28.25"
4 STEP	STP-211	37.5" – 42"	8"	26"		23.75" – 24.25"
	STP-214	37.5" – 42"	8"	30"		27.75" – 28.25"



LEARN MORE about the **STRUT ASSIST**



**BEFORE YOU ORDER —**  
Review the **Qualification Guide** to determine the correct Strut Assist for your unit.



# QUICK CONNECT STEP

Add sure footing into and out of your RV with ground-stable, removable Quick Connect RV entry steps. Easily detach your step system with quick-release latches. Even on rough terrain, adjustable feet give you bounce-free, wobble-free stability.

FEATURES

- Lightweight, removable design
- Durable construction
- Quick-release paddle latches
- Adjustable feet
- Industry-leading 500 lb weight capacity



Quick-release latch



Adjustable feet

## QUICK CONNECT FIT CHART

	PART NUMBER	STEP HEIGHT	STEP RISE
2 STEP	STP-221	21.5" – 27.5"	9"
3 STEP	STP-222	27.5" – 36"	8"
4 STEP	STP-223	35.5" – 44"	8"



### BEFORE YOU ORDER —

Review the **Pre-Installation Instructions** to determine the correct Quick Connect Step for your unit.

# FLIP TREAD STEP

These sleek steps offer the same stability as our standard StepAbove. To ensure your unit stays clean, the treads of this step easily flip up to remove dust and dirt before they fold up into your doorway. Flip Tread Steps are ideal for normal entry doors as well as floor plans with interior steps that protrude into the doorway.

FEATURES

- Lightweight pull-down design
- Durable construction
- Secure storage inside door entrance
- Adjustable feet
- Industry-leading 400 lb weight capacity
- Collapsible treads allow for easy cleaning



*Please note:* The bolt-on handrail isn't compatible with this model, but the Safe-T-Rail is a perfect solution.



## FLIP TREAD STEP FIT CHART

	PART NUMBER*	STEP HEIGHT	STEP RISE	DOOR WIDTH Size from Factory Label	—OR—	DOOR WIDTH Size from Flange to Flange
3 STEP	STP-217	30" – 37.5"	9"	26" – 30"		23.75" – 28.25"
4 STEP	STP-215	38" – 46"	9"	26" – 30"		23.75" – 28.25"



### BEFORE YOU ORDER —

Review the **qualifier** to determine the best Flip Tread Step for your unit.

# AIRSTREAM® STEP

Give yourself sure footing into and out of your Airstream® with a StepAbove RV step system. Our innovative 2-step design fits your threshold to give you bounce-free, wobble-free stability. Adjustable feet mean rough terrain is no problem for your StepAbove. The lightweight design opens easily and stores conveniently in your door entrance.

## FEATURES

- Retro 2-step design for Airstream®
- Lightweight pull-down design
- Durable construction
- Stores securely inside doorway
- Adjustable feet
- Industry-leading 500 lb weight capacity



### BEFORE YOU ORDER —

Review the **qualifier** to determine if the Airstream® step will work for your unit.



STP-216

# PATIO STEP

MORyde's ground stable patio steps offer added stability and safety as you enter and exit your rear or side patio.

## FEATURES

- Easily attach and detach
- Durable construction
- Secure storage inside door entrance
- Adjustable feet
- Industry-leading 500 lb weight capacity



Please call MORyde to determine the best step for your unit.



A New Generation of  
**STEP ABOVE**  
by MORyde

# STEPMates

Navigating Your RV Steps Made Easy

Products designed to work with your steps for added safety, storage and convenience.

## SAFE-T-RAIL

Entering and exiting your RV is now easier and safer with MORryde's Safe-T-Rail.

FEATURES

- Provides 54" of continuous rail surface and extends 42.5" from the RV wall
- Easy and quick to install
- Magnetic lock and secondary pin holds rail in place during travel



**BEFORE YOU ORDER —** review the **qualifier** to determine if it will work for your unit.



PATENTED

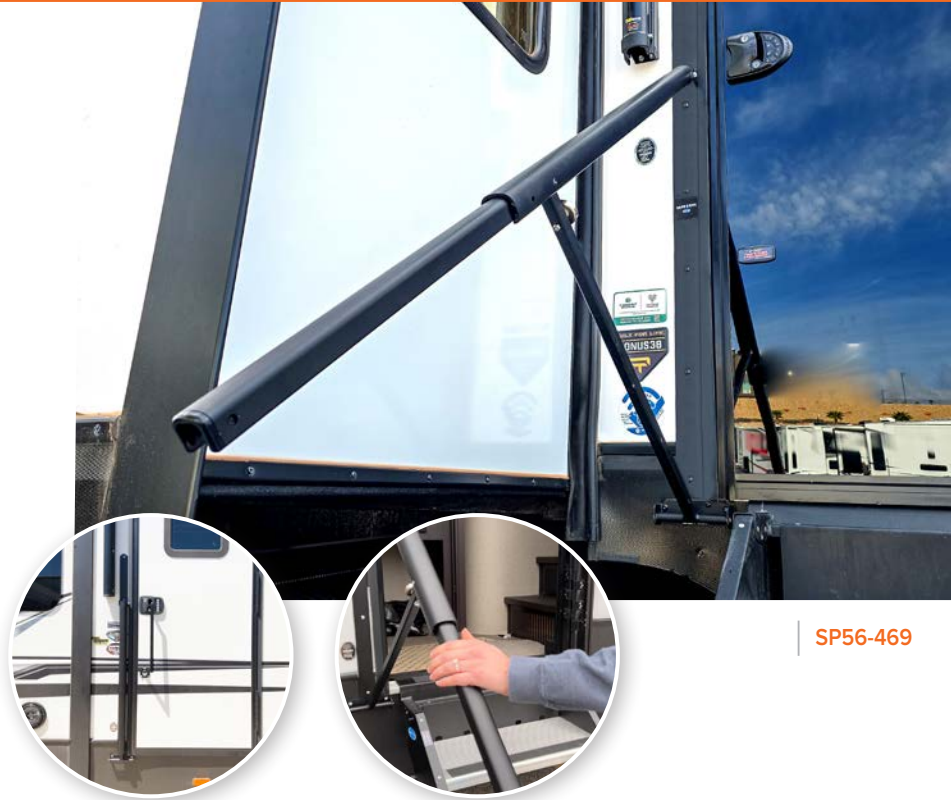

SP56-469

## SHORT SAFE-T-RAIL



FEATURES

- Provides all the benefits of the original Safe-T-Rail with a compact design.
- Extends 34" from the RV
  - Offers nearly 48" of continuous rail surface



PATENTED



SP56-573

## MOTORHOME SAFE-T-RAIL



FEATURES

- Replaces small door handle
- Offers a smooth continuous handrail for easy entry and exit of the RV
- Extends 16" out from the motorhome and offers nearly 36" of continuous railing



SP56-632

# LATCH EXTENDER

The Latch Extender offers additional leverage when getting into your RV. Its longer handle and larger gripping surface make it easy to open your door—without the hassle of going up and down the steps. Compatible with most standard and keypad door latches.

FEATURES

- Attaches to your RV door lock
- Extended handle provides a larger gripping surface
- Makes it easier to reach and open your door from the ground
- Reduces unnecessary trips up and down your entry steps



SP54-200



**BEFORE YOU ORDER —**  
review the **qualifier** to determine if it will work for your unit.



*Note: The Latch Extender is designed for opening the door only. Do not use to close the door.*



# HANDRAIL

Get added stability with the StepAbove handrail. Available for three and four step models.

FEATURES

- Lightweight design
- Left-side attachment
- Folds into entrance doorway
- Durable construction
- Black powder coated finish
- Simple bolt-on installation

## Please Note



36" of clearance inside the doorway is needed for any handrail to be added to your RV. If you are unsure about which StepAbove model you own, please call the parts department at 574-293-1581.

Designed for  
**1ST GENERATION STEPABOVE**

- 3 Step  
**STP214-029H**
- 4 Step  
**STP214-006H**

Designed for  
**2ND GENERATION STEPABOVE**

- 3 Step  
**STP214-121H\***
- 4 Step  
**STP214-120H\***

\* Not compatible with the Flip Tread or Patio Steps.



# HANDRAIL POCKETS

Easily set-up and remove a handrail on any Gen II StepAbove Steps with these bolt on Step Handrail Pockets.

3 Step  
**STP54-048H**

4 Step  
**STP54-049H**



# STORAGE BOX

A perfect storage solution that replaces the stock steps after a StepAbove is installed.

FEATURES

- Lockable door to secure your items
- 25.75" wide, 10" tall and 10.5" deep, approximately 1.5 cubic feet of space
- The box is made of durable steel with a lockable aluminum door
- Durable powder coated finish
- Fits most step mounts
- Simple bolt-on installation

Lockable box



SP54-099

Please note: The storage box is not watertight or waterproof and may allow moisture inside.



**BEFORE YOU ORDER —**  
Review the **qualifier** to determine if the Storage Box will work for your unit.

# STEP TREAD COVERS

Introducing MORryde's Step Tread Covers for RV Entry Steps – a sleek, form-fitting design crafted from marine-grade flooring material. These covers are water-wicking and slip-resistant, ensuring a safe and durable solution for your RV steps.

- Designed for narrow and deep models
- Pet-friendly
- Stick-on installation

Available for purchase as multi-step packs (compatible with Gen 2 steps) or individual covers to suit your RV needs!

Prevent dirt tracking into the RV with marine-grade Step Tread Covers.



LEARN MORE ABOUT STEP TREAD COVERS

## STEP TREAD COVERS FIT CHARTS

MULTI-PACK

STEP SIZE	QUANTITY & SIZE	PART #
3 Step Wide	(1) 23.5" x 9.5" & (2) 23.5" x 7"	STP54-066
4 Step Wide	(1) 23.5" x 9.5" & (3) 23.5" x 7"	STP54-067
2 Step Narrow	(1) 19.5" x 7" & (1) 19.5" x 9"	STP54-068
3 Step Narrow	(1) 19.5" x 9.5" & (2) 19.5" x 7"	STP54-069
4 Step Narrow	(1) 19.5" x 9.5" & (3) 19.5" x 7"	STP54-070

INDIVIDUAL

Deep Step (wide)	(1) 23.5"x9.5"	STP54-071
Shallow Step (wide)	(1) 23.5"x7"	STP54-072
Deep Step (narrow)	(1) 19.5"x9.5"	STP54-073
Shallow Step (narrow)	(1) 19.5"x7"	STP54-074



## ADD-A-STEP TREAD

- Adjustable for 8" and 9" rises
- Available in two widths (23.5" and 19.5")
- Attaches to any Gen 2 StepAbove® step
- Closes the gap when the first step is too tall
- Easy to attach and remove
- Comes with longer legs to accommodate height difference



Scan the QR code to learn more!

Please note

The Add-A-Step is designed to work only with MORryde Gen 2 StepAbove® steps (including the Strut Step version) — you'll recognize them by their wider top step. It is not compatible with MORryde Gen 1 StepAbove, MORryde Flip Tread Steps, LCI Solid Step®, or Torklift GlowStep®, so be sure to verify your step model before ordering.

### ADD-A-STEP TREAD FIT CHART

	STEP TYPE	TREAD SIZE	PART NUMBER
INDIVIDUAL	Wide Step	(1) 23.5" x 7"	STP54-075
	Narrow Step	(1) 19.5" x 7"	STP54-076



## STEP GRAB HANDLE

Create extra stability when lowering the StepAbove by adding a Grab Handle.

FEATURES

- Provides additional ease when lowering
- Attaches underneath step tread
- Simple bolt-on installation



STP54-044

## STEP BRUSH

Keep dirt and debris out of your RV with the innovative StepBrush. Designed to mount securely underneath your StepAbove entry steps, this brush is the perfect solution for maintaining a cleaner RV.

- **Dual-Purpose Design**  
Clean shoes or sweep your steps
- **Secure Mounting**  
Convenient and space-saving solution
- **Quick Removal**  
Effortlessly detaches for standalone use
- **Durable Construction**  
Built for the outdoors and daily use



STP54-062



Scan the QR code to learn more!

**Please Note** → The Step Brush is only compatible with Gen 2 steps.

## REMOVABLE HINGE PLATE\*

Convert standard StepAbove steps to a quick-release style and easily remove them when a unit is in storage or parked in tight spaces.

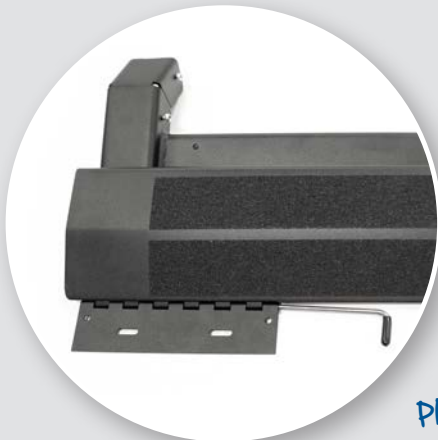

26" Door  
STP54-030

30" & 32" Doors  
STP54-031

**Please Note** →

The Removable Hinge Plate is designed for first-generation StepAbove units. The quick-release style comes standard on second-generation StepAbove units. Not recommended for use with the Strut Step, as it will eliminate the strut assist feature.



STP57-430-AM

## STEP LEGS

The StepAbove Extended Legs\* replace the support legs for your Gen 2 MORryde StepAbove RV steps.

- Extended step legs offer 2" of additional height adjustment over the standard step legs.

\*2 extending legs included.



## STEP LATCH

Add a lockable feature to the Strut Assist StepAbove with a Step Latch.

- Provides additional security while stored in doorway
- Easy-to-use pull latch mechanism
- Simple bolt-on installation

STP57-169LH

# RUBBER PIN BOX



Leave rough towing behind with MORryde's revolutionary Pin Box System. Its advanced rubber shear spring works to absorb towing shock for more comfortable, stress-free travel.

- Jerk-free starts and stops
- 3" fore/aft travel and 1.5" side-to-side travel
- Maintenance-free
- Reduces back-and-forth chucking and jerking
- Cushioned sensation over uneven roads
- Uses 100% natural rubber shear springs

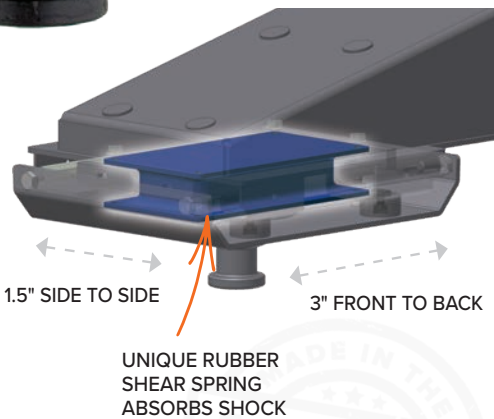

➔ Not compatible with Curt Cross-Wing™ Hitches.

## Rubber Pin Box Replacement Parts Kit

Restore your MORryde Rubber Pin Box with this replacement parts kit. Designed to refresh key components and extend the life of your pin box. Rubber shear spring sold separately.



## Heavy-Duty Rubber Pin Box Adapter Kit

Used with a MORryde Rubber Pin Box when connecting to a gooseneck adapter or a Anderson Ultimate 5th Wheel Hitch. One size fits all MORryde Rubber Pin Box models.

RPB72-010

## Pull Rite Adapter Kit

Used with the Pull Rite SuperGlide hitch.



RPB77-001

## Pin Box Stability Disc Replacement Kit



RPB77-009

## FIT CHART

Cross Reference Guide		Order according to GVWR of the trailer, not the GVW of the pin box.*				MORryde Pin Box Rating
MFG	MODEL#	11,500 or less	11,501 - 14,000	14,001 - 18,000	18,001 & over	
Lippert	1621, SHD-TA	N/A	N/A	RPB72-1621SHD-TA-05	RPB72-1621SHD-TA-06	24k
Lippert	1621HD	RPB72-1621HD-03	RPB72-1621HD-04	RPB72-1621HD-05	N/A	21k
Lippert	1621SHD	N/A	N/A	N/A	RPB72-1621SHD-06	23k
Lippert	1116	RPB72-1116-03	RPB72-1116-04	RPB72-1116-05	RPB72-1116-06	19k
Lippert	1716	RPB72-1716-03	RPB72-1716-04	RPB72-1716-05	N/A	18k
Lippert	Rhino	RPB77-FD-03	RPB77-FD-04	RPB77-FD-05	RPB77-FD-06	24k
Leland	7900	RPB72-7900-03	RPB72-7900-04	RPB72-7900-05	N/A	15k
Leland	7920, 7921	RPB72-221002300-03	RPB72-221002300-04	RPB72-221002300-05	N/A	19k
Dexter	221-0023-00	RPB72-221002300-03	RPB72-221002300-04	RPB72-221002300-05	RPB72-221002300-06	19k
Dexter	221-0031	RPB72-2210031-03	RPB72-2210031-04	RPB72-2210031-05	N/A	16k

## To order a pin box system, please identify the following:

- Model Number of the stock pin box (usually found on a label on the pin box)
- GVWR\* of the trailer: MORryde has a specific rubber spring for different weight ratings

OR

### If the stock part number is not available:

- Determine the bolt pattern (A),
- Measure the width (B)
- Measure the distance from center of king pin to center of first row of bolts (C)
- Scan the QR code to convert these measurements into a MORryde part number.

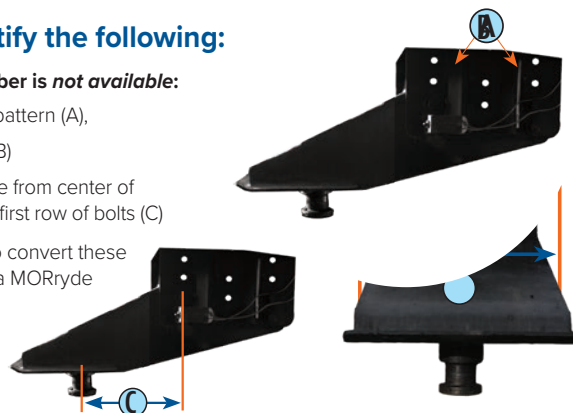

ID GUIDE



# GOOSETECH

## RUBBER GOOSENECK BOX



From the industry leader in suspension and pin box technology, the MORryde GooseTech utilizes a unique rubber shear spring to cushion and soften harsh road shock.

### FEATURES

- Replaces the pin box to free up truck bed space
- Improved towing comfort
- Matches OEM pin location
- Hole in the coupler allows for a security lock
- 3" fore/aft travel
- Auto-latching coupler
- Remote release handle
- Maintenance-free
- Tested to CSA standards



Scan to view ID GUIDE



3" fore/aft travel

### FIT CHART

Cross Reference Guide		Order according to GVWR of the trailer, not the GVW of the pin box.*				MORryde Pin Box Rating
MFG	MODEL#	11,500 or less	11,501 - 14,000	14,001 - 18,000	18,001 & over	
Lippert	1621SHD	RGN74-1621SHD-03	RGN74-1621SHD-04	RGN74-1621SHD-05	RGN74-1621SHD-06	24k
Lippert	1116	RGN74-1116-03	RGN74-1116-04	RGN74-1116-05	RGN74-1116-06	19K
Lippert	1716	RGN74-1716-03	RGN74-1716-04	RGN74-1716-05	N/A	18k
Lippert	Rhino	RGN74-FD-03	RGN74-FD-04	RGN74-FD-05	RGN74-FD-06	24k

### GooseTech Safety Chain



RGN77-001

### Tow With Confidence

- 26,000 lb rated
- 84.5" length with hooks
- 3/8" Grade 70 yellow zinc
- Grade 70 clevis slip hooks

## CARD KEEPER

Easily stores your 7-way power cord

### FEATURES

- Great for travel trailers and 5th wheels
- Safe, secure cord storage
- Stores outside the Pin Box to keep cord off the ground
- Helps prevent wire cuts and fraying
- Strong magnetic application



SP56-463



## EXTENSION CORD KEEPER

### FEATURES

- Efficient storage solution for your extension cord
- Unobtrusive mount saves space in your baggage compartment
- Stores up to 50' of an extension cord or ethernet/coaxial cable
- Docking plate and hardware included

SP56-658



You can even store your cable cord!



# SUSPENSION SYSTEMS

Smoo



## CRE3000

Designed for towing improvement over the standard stock equalizer.

FEATURES

- Provides 3" of suspension travel
- Smoother towing than conventional leaf springs
- Protects from damaging road shock
- Unique travel slot for increased wheel travel
- Easy bolt-on installation
- 2 year warranty
- Utilizes rubber to cushion shock



	PART #	WHEEL BASE	BEAM WIDTH
TANDEM	CRE2-33	33"	N/A
	CRE2-35	35"	N/A
TRIPLE	CRE2-1000	42"	10"
	CRE2-1475	42"	14 3/4"
	CRE3-33	33"	N/A
	CRE3-35	35"	N/A

UP TO 8,000 GAWR



Review the CRE3000 qualification guide to determine compatibility.



Unique Travel Slot



## ALLTREK 4000

Designed to protect your trailer all the time, wherever you tow.

FEATURES

- Provides 4" of suspension travel
- Over 40% more rubber than the CRE3000 for smoother, more comfortable towing
- Protects trailer from damaging road shock
- 2 year warranty
- The most rigorously-tested MORryde equalizer suspension to date
- Easy, bolt-on installation

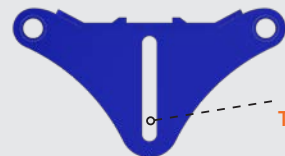

Unique Travel Slot



Review the AllTrek 4000 qualification guide to determine compatibility.

	PART #	WHEEL BASE
TANDEM	TG2-33	33"
	TG2-35	35"
TRIPLE	TG3-33H	33"
	TG3-35H	35"

UP TO 8,000 GAWR

# Smooth Out ROUGH ROADS



## INDEPENDENT SUSPENSION

The independent design of the MORryde I.S. system allows each wheel to respond individually to the road. That means your unit glides easily over uneven and rough roads to give you the comfortable ride you deserve.

FEATURES

- Provides up to 5.5" of suspension travel
- Much smoother towing than conventional leaf springs
- Better protection of the trailer from rough roads
- Far more durable than leaf spring suspension systems
- 5-year warranty



LEARN MORE ABOUT THE I.S.

Call **574-293-1581** or email us at [parts@MORryde.com](mailto:parts@MORryde.com) to schedule your installation appointment.

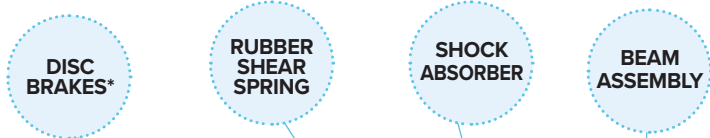

**Join the I.S. Owners' Club!**  
Ask the service department for details.

### Independent Suspension Shock Absorber Kit

Many Independent Suspension Systems come standard with shock absorbers. If yours does not — or if you're replacing worn shocks — this kit is the right solution.



- Includes:
- (2) Loop Shock Absorbers
  - (4) Mounting Bolts
  - (4) Mounting Nuts

IS12-068

Please note: Sold per axle. Order two kits for tandem axles and three kits for triple axles.

\* Disc brakes shown are sold separately.

# HEAVY-DUTY SHACKLE KIT

Thick. Durable. Greasable.

The Heavy-Duty Shackle Kit is an excellent upgrade for your running gear.

FEATURES

- Thick shackles provide added strength
- Bronze bushings for more durability
- Greasable bolts make maintenance easy
- Complete peace of mind
- Lock nuts to ensure security



LEARN MORE ABOUT THE HEAVY-DUTY SHACKLE KIT

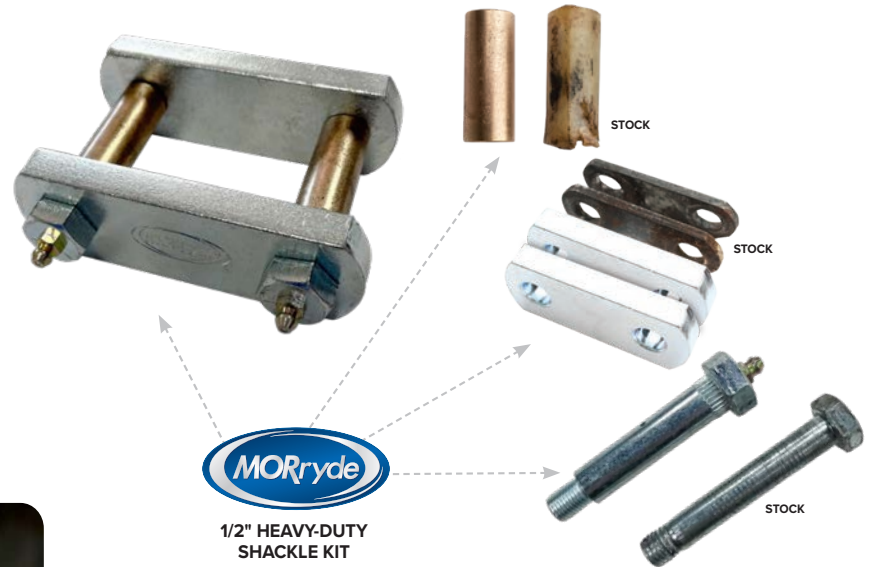

1/2" HEAVY-DUTY SHACKLE KIT



Order kit according to your current suspension system:

Part # Standard Frame Hanger

Part # OEM Correct Track Hanger

		Part # Standard Frame Hanger	Part # OEM Correct Track Hanger
MORryde LRE	tandem	LRE12-001	LRE12-016
	triple	LRE12-004	LRE12-017
AllTrek4000, CRE3000 and Rigid Equalizer with 2-1/4" shackles	tandem	UO12-016	UO12-029
	triple	UO12-023	UO12-030
Rigid Equalizer with 3-1/8" shackles	tandem	UO12-021	UO12-031
	triple	UO12-024	UO12-032

## X-FACTOR CROSSMEMBER

FEATURES

- Designed to greatly reduce frame stress
- Adjustable to fit different frame widths
- Provides added lateral strength
- Uses high-strength low-alloy steel
- No welding necessary
- Easy installation



LEARN MORE ABOUT THE X-FACTOR CROSSMEMBER

Please Note:

Only one crossmember per kit. Adding an X-Factor crossmember drop down adapter kit (XF12-003) will give 5" total clearance for an additional 3" of clearance compared to the standard version (XF12-001).

Part #	Description
RE21-004	Crossmember for MORryde LRE & RE suspensions
XF12-001	Crossmembers for standard frame hangers
XF12-002	Correct Track frame hanger adapter kit*
XF12-003	Drop-down adapter kit*

\* Requires purchase of XF12-001.

## U-BOLT KIT FOR LEAF SPRINGS



UO12-018

This 8" long U-bolt kit is intended to be used with 3" diameter trailer axles and includes nuts and washers to securely fasten.

- Kit includes (4) U-bolts, (8) washers, and (8) nuts
- Fits 3" diameter axles
- U-bolts are Grade 5, 8" long and 1/2" thick
- 1-year limited warranty

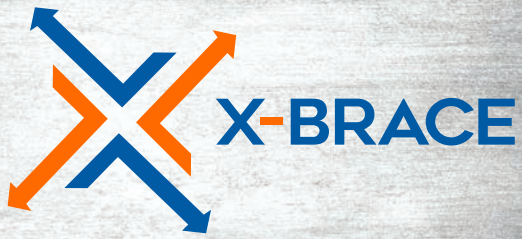

# EASY STABILIZING SOLUTIONS

X marks the spot for the simplest, most effective stabilizer. MORryde's X-Brace, a collaboration with Winfield Products, installs easily and provides rock-solid lateral support, keeping your trailer stable in any condition.



Added stability for any RV  
with a standard I-beam

## I-BEAM STABILIZER

*slides onto any exposed I-Beam*



SP54-253



Uses X-Brace design to provide  
exceptional stability

## 5TH WHEEL STABILIZER

*for Front Cross Braces on 5th Wheels*

SP54-180

Installs onto existing stabilizer  
jacks and locks in stability

## SCISSOR JACK STABILIZER

*for Travel Trailers*

SP54-181



Provides stability from excessive  
or unwanted movement

## HITCH MOUNT STABILIZER

*fits any Rear 2" Hitch Receiver*



SP54-182



Uses ratchet tensioning design  
for extra stability

## BIKE RACK STABILIZER

*fits most 2" bike rack shanks*



SP54-274

Easily installs in minutes | Exceptional stability | Easy adjustments | Stable camping experience

# POWER CORD REELS

A simple way to store your power cord.

## EASY REEL™ SPOOLERS

The Easy Reel™ delivers the simplest, smoothest, and most convenient way to effectively store your power cord.

FEATURES

- Conveniently stores your power cord
- Manual or motorized versions available
- Rugged steel construction
- Space-saving design
- Designed for detachable power cords

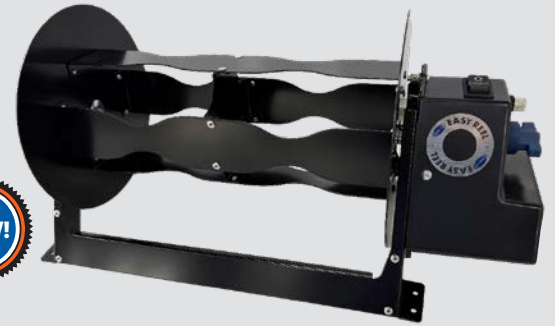

### Wide Mount Motorized Reel

Stores up to 30' of a 50-amp cord

FEATURES

- Powerful motor means no more strain
- Allows for efficient cord storage
- Easy 12 volt install
- Convenient in-line fuse
- Sleek design and rugged steel construction
- Can be mounted upside-down to maximize storage

**REEL56-019H**

**DIMENSIONS:**

23" w x 11.25" h x 10.375" d



### Tall Reel

Stores up to 50' of a 50-amp cord

**DIMENSIONS:**

7.6" w x 17.6" h x 21" d

**REEL56-001H**

### Economy Reel

Stores up to 30' of a 50-amp cord

**DIMENSIONS:**

14.3" w x 13.4" h x 12.8" d

**REEL56-009H**

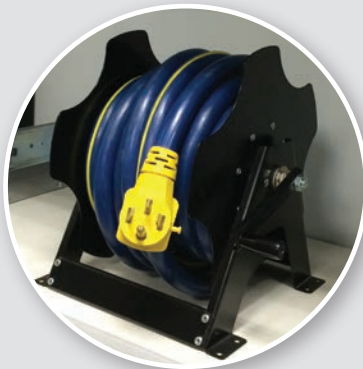

### Motorized Reel

FEATURES

- Motorized operation
- Store up to 30' of a 50-amp cord
- Rugged steel construction
- Ceiling mount option to maximize storage
- Convenient in-line fuse
- Space-saving design for efficient cord storage
- Designed for detachable power cords

**REEL56-014H**

**DIMENSIONS:**

16" w x 13.4" h x 12.8" d



LEARN MORE ABOUT  
EASY REEL SPOOLERS



LEARN MORE ABOUT  
THE MOTORIZED  
EASY REEL

NEW



| SP54-254



Keep your hitch equipment clean, secure and off the dirty ground with the EzSTOR Hitch®.

**SECURE STORAGE:** Locks your tow bars and hitch head in one place.

**SPACE-SAVING DESIGN:** Dedicated spot for hitch head and bars.

**PROTECTION:** Keeps your equipment off the ground and clean.

**EASY INSTALLATION:** Clamp-on design, no drilling required.

**VERSATILITY:** Perfect for travel and cargo trailers.

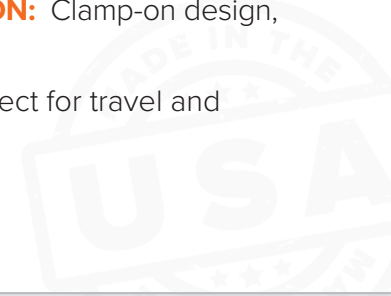

NEW

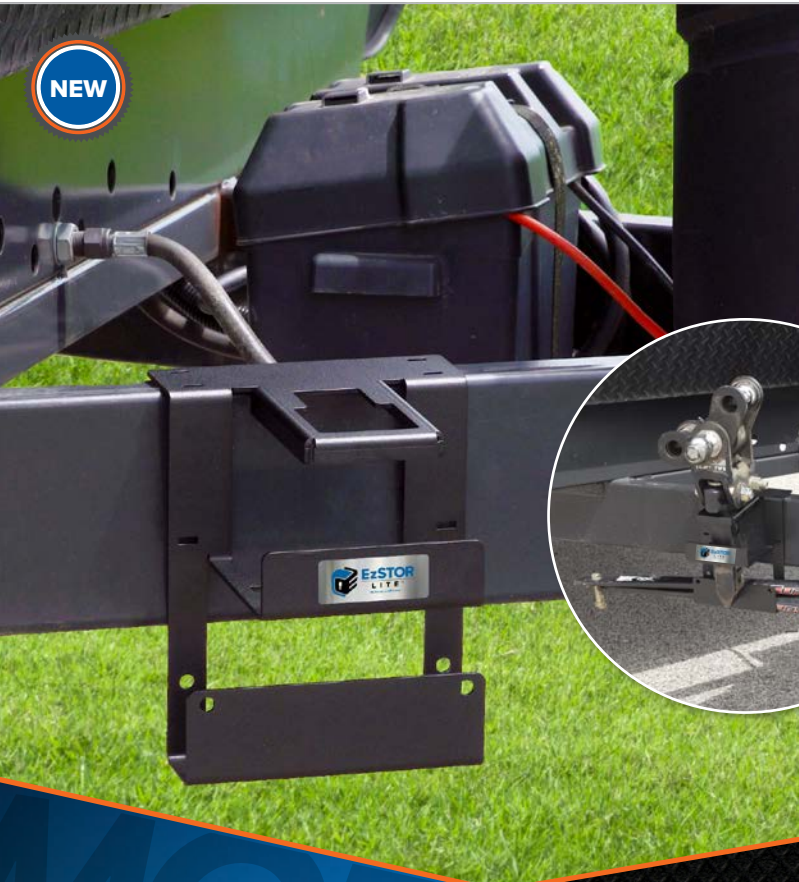

| SP54-257



Get the same benefits as the EzStor Hitch with added convenience.

The EzStor Lite™ easily sets over your travel trailer's A-frame, providing a neat space for weight distribution bars and hitch head—no bolting required!

Are your weight distribution bars and hitch always in the way?  
Tired of leaving them on the ground?

**WE HAVE THE SOLUTION!**





## KEY FEATURES

- ✓ Expanded living area
- ✓ Quick and easy to set up
- ✓ Adjustable shades for privacy
- ✓ Removeable 3-layer screens on sides and rear
- ✓ Compact pack size

| THP-EX3



## OPTIONAL ACCESSORY:

Electric Pump

| THP136-038



- Rechargeable battery
- LED display screen
- Inflates to 10PSI with auto cut off
- Power bank function

### PATIOEX 12-MONTH LIMITED WARRANTY

Scan QR code for details



### Please Note

For best performance, take down the PatioEx in any weather beyond light rain or light wind.

# WASTE MANAGEMENT

More information  
available at  
[EzRvSolutions.com](http://EzRvSolutions.com)

## RV SNAP TRAP®

NEW

The industry's first snap-on P-trap for RV sewer hoses. Instantly create a barrier against sewer gas and pests — no permanent install required.

FEATURES

- Fits standard 3" RV sewer hoses\*
- Snaps on in seconds
- Transforms your hose into a plumber-grade P-trap
- Blocks sewer gas and pesky sewer flies
- Helps eliminate odors inside your RV
- Install anywhere along the hose
- Quick setup, teardown, and storage
- Designed to allow your grey tank valve to remain open during use.

*Not compatible with Lippert Waste Master hoses.*



SP54-267

FIND DETAILED  
INSTRUCTIONS AT  
[ezrvsolutions.com/  
product-instruction/](http://ezrvsolutions.com/product-instruction/)

SCAN TO  
LEARN MORE!



NEW

## BLACK TANK BYPASS VALVE KIT

### The Original RV Residential Flush® System (3")

Bring residential toilet convenience to your RV—while saving water and reducing maintenance.

Easily switch between Black Tank and Residential Flush modes for a more flexible, efficient system.

FEATURES

- Works with RV and residential toilets
- Use your preferred toilet paper in residential mode
- Saves 30–100 gallons of water per cleaning
- Reduces black tank use, flushing, and chemicals
- Helps extend the life of your black tank system
- Compatible with manual, remote, and future motorized options



SP54-268

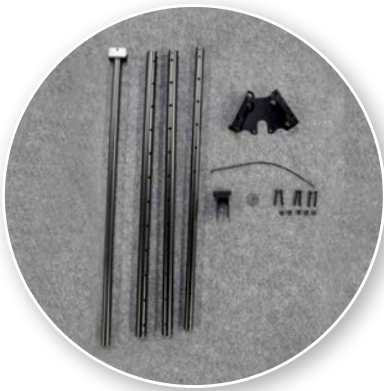

## MANUAL DRIVE KIT

### RV Residential Flush® Manual Drive Kit

Quickly switch modes with a simple turn of the handle. The face plate clearly shows your selection, while the adjustable shaft (24"–90") ensures a perfect fit for your setup.

NEW



SP54-269

# SLIDING TRAY SYSTEMS

Variety of storage solutions makes it easier to reach, organize, and stow your gear



## CARGO TRAYS

with **60% EXTENSION**

FEATURES

- Fully assembled
- 90" trays slide out from both sides of unit.\*
- Carpeted flooring
- Ball-bearing slide
- No measuring or cutting
- 800 lb weight capacity
- Extends 60%
- Easy to install



LEARN MORE ABOUT CARGO TRAYS

	36" L	48" L	60" L	72" L	90" L*
20" W	CTG60-2036W	CTG60-2048W	CTG60-2060W	CTG60-2072W	CTG60-2090W
23" W	CTG60-2336W	CTG60-2348W	CTG60-2360W	CTG60-2372W	CTG60-2390W
26" W	CTG60-2636W	CTG60-2648W	CTG60-2660W	CTG60-2672W	CTG60-2690W
29" W	CTG60-2936W	CTG60-2948W	CTG60-2960W	CTG60-2972W	CTG60-2990W
33" W	CTG60-3336W	CTG60-3348W	CTG60-3360W	CTG60-3372W	CTG60-3390W
36" W	CTG60-3636W	CTG60-3648W	CTG60-3660W	CTG60-3672W	CTG60-3690W
39" W	CTG60-3936W	CTG60-3948W	CTG60-3960W	CTG60-3972W	CTG60-3990W
42" W	CTG60-4236W	CTG60-4248W	CTG60-4260W	CTG60-4272W	CTG60-4290W
48" W	CTG60-4836W	CTG60-4848W	CTG60-4860W	CTG60-4872W	CTG60-4890W
52" W	CTG60-5236W	CTG60-5248W	CTG60-5260W	CTG60-5272W	CTG60-5290W

**800 LB WEIGHT CAP ON ALL CARGO TRAYS LISTED ABOVE**

## CARGO TRAY RISER KIT

Raise your RV storage system with a cargo tray extender. This easy-to-install kit gives your sliding tray the extra height it needs to clear the lip of your basement compartment.

FEATURES

- Height adjustments (1.625", 2.5", 2.8", 3.125")
- 800 lb weight capacity
- Easy to install
- Works with all MORryde Cargo Trays
- Each kit includes 6 riser brackets

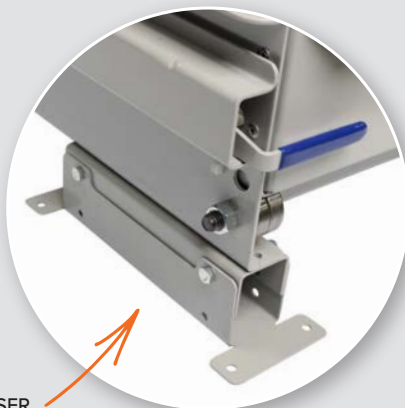

RISER BRACKET

CTG54-001

## 72" CARGO TRAYS

with **80% EXTENSION**

Trays slide out from both sides of unit.

SIZE	PART#	WEIGHT CAP.
20"W X 72"L	CTG80-2072-2DW	500 lb
23"W X 72"L	CTG80-2372-2DW	500 lb
26"W X 72"L	CTG80-2672-2DW	500 lb
29"W X 72"L	CTG80-2972-2DW	500 lb
33"W X 72"L	CTG80-3372-2DW	500 lb
36"W X 72"L	CTG80-3672-2DW	500 lb
39"W X 72"L	CTG80-3972-2DW	500 lb
42"W X 72"L	CTG80-4272-2DW	500 lb
48"W X 72"L	CTG80-4872-2DW	500 lb
52"W X 72"L	CTG80-5272-2DW	500 lb

# UTILITY TRAYS

Conveniently store your RV generator on a sliding utility tray that easily opens and closes. It's easy to install, simple to use, and extends fully to give you quick access to your gear.

FEATURES

- Durable powder coat
- 100% extension
- Roller bearing slides
- No assembly required
- 150-300 lb weight capacity (varies by size)



LEARN MORE ABOUT UTILITY TRAYS

	DIMENSIONS: (w x d x h)	WEIGHT CAPACITY
<b>SP60-041</b>	14" x 14" x 2.75" (inside) 16.25" x 15.75" x 5" (outside)	250 lb
<b>SP60-042</b>	14" x 21" x 2.75" (inside) 16.25" x 22.75" x 5" (outside)	250 lb
<b>SP60-043</b>	21" x 14" x 2.75" (inside) 23.25" x 15.75" x 5" (outside)	250 lb
<b>SP60-044</b>	24" x 24" x 2.75" (inside) 26.25" x 25.75" x 5" (outside)	300 lb
<b>SP60-047</b>	20.25" x 17.5" x 2.75" (inside) 22.75" x 19.25" x 3.25" (outside)	250 lb

# FREEZER TRAYS

These 200% extension slides are great for your freezer, refrigerator, or any cargo that you would like to access past the unit's slide-out.

FEATURES

- 225 lb weight capacity
- Ready to install in minutes
- Durable powder coat



WIDE PULL



NARROW PULL

	DIMENSIONS: (w x d x h)	WEIGHT CAPACITY
<b>SP56-115</b> <i>Wide Pull</i>	37.6" x 21.6" x 5" (outside) 31.42" x 19.7" x 2.5" (inside)	225 lb
<b>SP56-132</b> <i>Narrow Pull</i>	18" x 26.5" x 6" (outside) 14" x 24.8" x 2.5" (inside)	225 lb
<b>SP56-388</b> <i>Wide Pull</i>	41.57" x 22.66" x 5" (outside) 37.62" x 21.17" x 2.5" (inside)	225 lb

# SLIDING TRAY SYSTEMS

MADE IN THE USA

## GRIDDLE TRAY

FEATURES

- Fits most 24" RV griddles
- Dual locks for cooking stability
- Spacious surface with clip-on counter tops
- Tie-down strap for secure travel
- Durable, corrosion-resistant construction
- 100% extension



SP56-567

**DIMENSIONS:** (w x d x h)

**WEIGHT CAPACITY**

22.5" w x 25.375" d x 4.125" h — closed w/o shelves

22.5" w x 49.25" d x 4.125" h — open w/o shelves

38.75" w x 49.25" d x 4.125" h — open w/ both shelves

100 lb

## DROP DOWN GRIDDLE TRAY

The MORyde Drop Down Griddle Tray offers a convenient cooking solution for tall RVs. It extends 23.75" and drops 8" to fit most 24" griddles, making outdoor cooking more accessible.

FEATURES

- Compact when retracted:  
9.75" H x 25.375" W x 21.75" D
- Expands to 45.5" D when fully extended
- 225 lb weight capacity
- Quick and easy installation
- Durable powder coat finish



SP56-727

# HIDDEN DROP DOWN TRAY

Take advantage of every inch of space in your RV with a hidden storage cargo tray. It fits in the top recess of the storage compartment and glides down and out to give you easy access to contents. The drawer stays hidden and out of the way when closed.

## FEATURES

- Installs in top storage compartment recess
- 65% extension
- 25 lb weight capacity
- Stays hidden when tray is closed
- Glides down and out
- Slides easily back into place



SP56-203

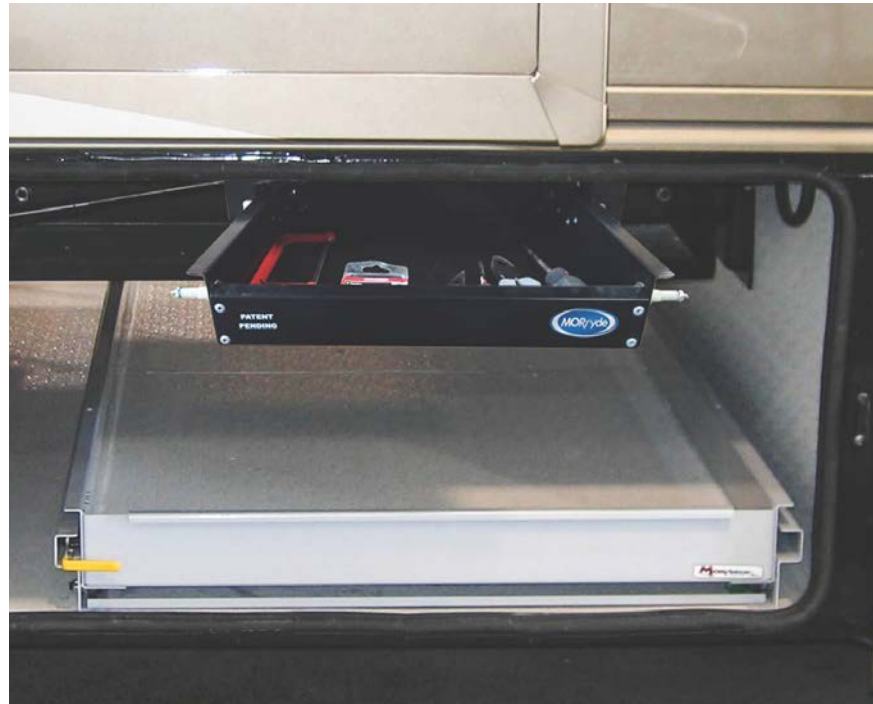

DIMENSIONS: (w x h x d)

26.3" w x 16.1" l x 2.7" h x 4.6" d

WEIGHT CAPACITY

25 lb



NEW

# DROP N STOW TRAY

The Drop N Stow Tray keeps your folding tables tucked away, secure, and ready when you need them.

## FEATURES

- Concealed storage tray for 6' collapsible tables
- Fits neatly into recessed basement compartments of 5th wheels.
- Perfect for storing tools, chairs, or solar panels—making the most of every inch of unused space.



SP54-249

DIMENSIONS:

31.75" w x 37.75" d — tray inside  
32" w x 38" d — tray outside  
36.75" with adjustable depth — mounting width

Our steel TV Mounts are well-known for rugged quality and sleek functionality. Perfect for recreational vehicles, hospitality suites, and home patios.

# TV MOUNTS

## WALL MOUNTS

### Swinging

This unique design offers a full range of viewing options. Double joint arm extends 18" and swings up to 360°. Locks in for safe travel.



- Tilts  $\pm 8^\circ$  forward & backward
- Tilts  $\pm 5^\circ$  side to side
- 24" of extension
- TV Swivels up to 360°
- Up to 200 x 200 VESA
- Spring latch holds mount secure in closed position

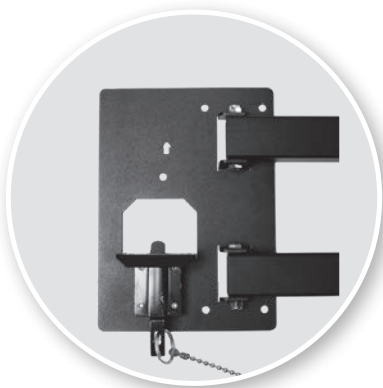

#### DIMENSIONS:

18.288"w x 9.75"h x 2.625"d (closed)  
9.5"w x 9.75"h x 24"d (open)



**TV1-123H**



- Tilts  $\pm 8^\circ$  forward and backward
- Tilts  $\pm 5^\circ$  side to side
- Offers 17" of total extension, and 360° of swivel
- Spring latch holds mount secure in closed position
- Back plate mounts separately from wall mount for easy install

#### DIMENSIONS:

14.85"w x 9.75"h x 2.625"d (closed)  
9.5"w x 9.75"h x 17"d (open)



**TV1-122H**

Follow these steps to find out which TV Mount is best for your application.

## STEP 1

### VESA HOLE PATTERN OF TV OR MONITOR?

VESA patterns available with MORryde TV mounts:  
 75 x 75 • 100 x 100  
 200 x 200 • 300 x 300  
 400 x 400

## STEP 2

### WEIGHT OF THE TV OR MONITOR?

MORryde mounts are available in these weight capacities:



## STEP 3

### TV INSTALLATION LOCATION

Range of motion desired:

- SWIVEL left to right
- SLIDING in & out
- TILT up & down
- FLIP up or down

## WALL MOUNTS

### Snap-In

These unique TV mounts allow for easy removal and reattachment of a flat screen TV without the hassle of unscrewing the TV from the mount.



#### Small Rigid

- Up to 100 x 100 VESA



**TV1-051H**

#### DIMENSIONS:

5.8" w x 5" h x 1.75" d



#### Rigid

- Up to 200 x 400 VESA



**TV1-048H**

#### DIMENSIONS:

18.47" w x 16.5" h x 2.1" d



#### Extend & Swivel

- Up to 200 x 200 VESA



**TV10-E-35H**

#### DIMENSIONS:

10.5" w x 8.9" h x 5.3" d (min) / 15.3" d (max)



#### Rigid

- Up to 200 x 200 VESA



**TV10-F-35H**

#### DIMENSIONS:

9.8" w x 8.8" h x 2" d



#### Swivel

- 200 x 200 VESA



**TV10-S-35H**

#### DIMENSIONS:

9.8" w x 8.5" h x 3.8" d

## PORTABLE MOUNTS

Each Portable TV Mount includes two docking plates, offering versatile placement options for entertainment anywhere.

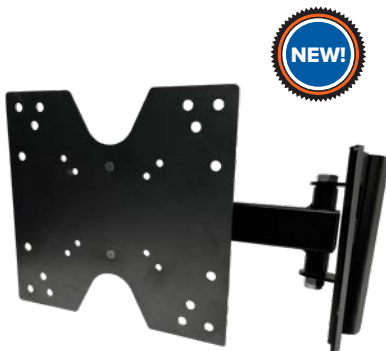

### Docking Wall Mount

- Tilts  $\pm 8^\circ$  forward & backward
- Tilts  $\pm 5^\circ$  side to side
- Low profile
- Up to 200 x 200 VESA
- Two docking plates

#### DIMENSIONS:

13.5" W x 9.125" H x 3.375" D (closed)  
 9" W x 9" H x 15.75" D (open)



**TV5-017H**

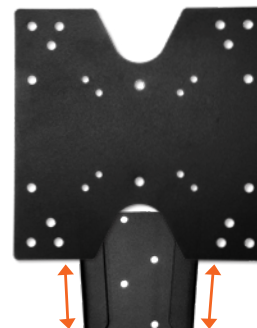

### Low Profile Rigid

- Up to 200 x 200 VESA
- Rigid mount for vertical surface
- Perfect for tight spaces
- Includes 2 docking plates
- Tilts  $\pm 5^\circ$  side to side



**TV5-021H**

#### DIMENSIONS:

9.125" w x 9.125" h x 0.875" d

## CEILING MOUNTS



### Drop Down

The Drop Down Ceiling Mount saves space and allows you to keep your TV out of the way until it is needed. The friction pivot lowers the TV slowly and allows you to position it at many viewing angles. This mount is perfect for storing your TV in tight spaces.



- Swings down from ceiling
- Friction pivot allows for a variety of viewing angles
- Up to 24" TV
- VESA: 75 x 75, 100 x 100, 100 x 200, 200 x 200



**DIMENSIONS:**  
8.6"w x 14.77"h x 5.58"d  
(in down position)

**TV1-080H**

### Slide-Out & Flip Down

This mount attaches to a horizontal surface or ceiling, most commonly inside a basement cargo bay. It can then slide out of the compartment, flip down, and swivel.



- Ideal for baggage compartments
- Slides out 17"
- Swivel & Tilt
- 200 x 200 VESA



**DIMENSIONS:**  
8"w x 7.5"h x 21"d (min)  
38"d (max)

**TV40-010H**

## ADAPTER PLATES

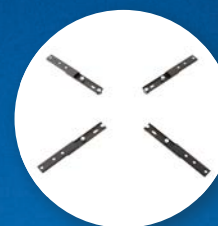
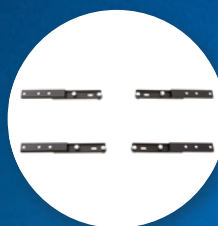

**VESA**  
200 x 400  
300 x 300  
400 x 400

**TV54-014H**

Two Configurations Available



**TV54-009H**

**VESA**  
100 x 200  
200 x 200



**TV1-008H**

**VESA**  
300 x 300  
300 x 400  
400 x 400

### Flip Down

This mount is excellent for under-cabinet installation or reinforced ceilings. Flip down while viewing and flip up to store it out of the way.



- Swings up & out of the way
- Locks in for safe travel
- Swivel & tilt
- Up to 24" TV
- 100 x 100 VESA



**DIMENSIONS:**  
6.5"w x 12.8"h x 8"d  
(in down position)

**TV56-010H**



**TV1-129H**

**VESA**  
400 x 400

# BASE MOUNTS



## Slide Out

Designed to swivel and slide out, this bracket is perfect for installation in a cabinet or corner.



- Slides out 7"
- Swivels
- Tilts 0 -10.5°
- Adjust for TV height
- Up to 200 x 200 VESA
- Locks in extended and retracted positions



**DIMENSIONS:**  
6"w x 17"h (tall) or  
12.5"h (short) x 15.8"d

**TV40-001H**  
Tall — up to 55" TV  
**TV40-001H-S**  
Short — up to 32" TV

## Base or Ceiling

This mount is excellent for under-cabinet installation or reinforced ceilings. It can also be mounted to a counter or desk for a great monitor mount.



- Swivel and tilt
- Up to 28" TV
- Up to 100 x 100 VESA
- Requires reinforced structure when used as a ceiling mount



**DIMENSIONS:**  
6.5"w x 11.5"h or 4.5"d

**TV1-012H**

## Rigid Adjustable

This low profile TV mount with adjustable mounting height is perfect for your new flat screen. Easy to install and the hardware is included.



- Adjust for TV height
- Up to 200 x 200 VESA
- Up to 40" TV
- Base plate faces toward the front



**DIMENSIONS:**  
8.9"w x 12.4"h (min) or  
17.6"h (max) x 6"d

**TV1-003H**

## Rigid

This low-profile wall mount is ideal for your flat-screen TV or monitor in your RV. It comes fully assembled for easy installation.



- Low profile design saves space
- Up to 200 x 200 VESA
- Mounts on any vertical surface
- Easy install



**DIMENSIONS:**  
8.85"w x 11"h x 1.14"d

**TV1-002H**

## Swivel or Rigid

This mount is excellent for under the cabinet installation or reinforced ceilings. It can also be mounted to a counter or desk for a great monitor mount.



- Low profile
- Up to 200 x 200 VESA
- Single stud install
- Swivels ±15°



**TV1-001H** — Swivel  
**TV1-002H** — Rigid

**DIMENSIONS:**  
8.75"w x 11.3"h x 4"d (swivel)  
or 1.1"d (rigid)

## WALL MOUNTS

### Drop-Down

The Drop Down Wall Mount extends from the wall and lowers to reduce glare and improve your viewing angle.

- Low profile when closed
- Pulls straight out
- Swivels for a variety of viewing positions
- Locks in place for safe travel
- 100x100 & 200x200 VESA



**WEIGHT CAPACITY:**  
12lbs (min) - 20lbs (max)

**TV56-129H**

**DIMENSIONS:**

13.3"w x 17.6"h x 5.2"d (up position)  
13.3"w x 29"h x 8.5"d (down position)

## HORIZONTAL SLIDING MOUNTS

These sliding TV mounts are designed for RV baggage compartments, offering multiple lockable angles for optimal TV viewing.

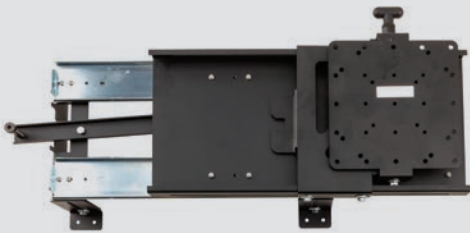

- 200 x 200 VESA
- Extends 22"
- Pivots 120°
- Space-saving



**TV40-002H**

**DIMENSIONS:**  
24.25"w x 13"h x 6.5"d

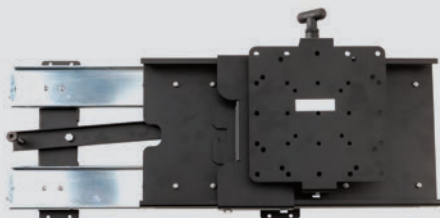

- 200 x 200 VESA
- Extends 20.5"
- Pivots 180°
- Space saving



**TV40-011H**

**DIMENSIONS:**  
20.75"w x 11.5"h x 4.6"d

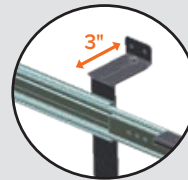

Brackets extend an extra 3" to clear the cargo bay lip



**TV40-002H**



Horizontal Mounts Retracted

Conveniently holds dinette chairs  
in place without straps

# THE CHAIR BUDDY™

Conveniently secure the dinette chairs in your RV with the Chair Buddy™. No need for bulky, awkward straps. The Chair Buddy holds everything in place during travel and folds out of the way when you don't need it. Look for the "T" in the handle to ensure it is a genuine MORryde Chair Buddy.

## FEATURES

- Effectively secures your chairs which helps protect from damage while traveling
- Clean, sturdy design
- Installs in minutes
- Easily folds out of the way
- No straps

LOOK  
for the "T"

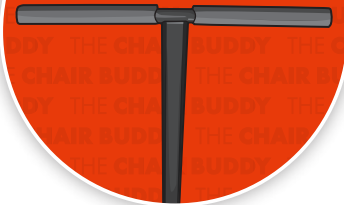

## Don't have a vertical column to attach your Chair Buddy?

No problem! Our Chair Buddy adapter allows you to attach your Chair Buddy to the underside of your tabletop.



LEARN MORE ABOUT  
THE CHAIR BUDDY



Chair Buddy  
**CB56-001H**

Chair Buddy Adapter  
**CB56-002H**

ABOVE. BEYOND. ALWAYS.

**At MORryde, we have a passion for building quality products.**

Today's RVers are wanting quality products that will help them enjoy their RV and the RV lifestyle even further. MORryde is committed to designing and producing quality products that meet and exceed their expectations. And it doesn't stop at the sale. We stand behind our products, believing in quality first, service always. No matter the issue, we'll be committed to doing MORE for our customers.



Above. Beyond. Always.

1966 Sterling Avenue • Elkhart, IN 46516  
574-293-1581 • sales@MORryde.com  
www.MORryde.com

We reserve the right to make changes or additions to the information and data provided, such as technical specifications, product numbers, price, design of products, without prior notice. 4/26



SUBSCRIBE  
TO OUR  
MAILING LIST!